

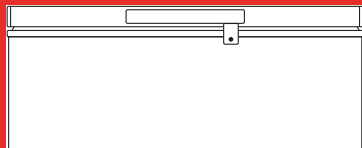

Hoover's quick & snappy start up guide.

371 L Chest Freezer



Model #:	HV-RCF371
Version #:	V1.0
After Sales Support	1300 886 649

Let's get your chest freezer up and running!

Welcome to your new Hoover freezer! We hope that this product brings you many years of enjoyment.

Comprehensive installation instructions, diagrams and safety advice are provided in the supplied instruction manual.

CAUTION! The freezer is heavy - transport it with care! To avoid back or other injury, we recommend you ask someone for help or use a mechanical aid when moving it.

Installation

- Before you start installing the freezer, wipe the interior surfaces and accessories with a damp cloth to remove any dust from transit and storage. Dry thoroughly.
- Tilt the freezer carefully - not more than 45 degrees - and move it to its designated place. Use the roll wheels under the back corners to help you position it in place and the levelling feet at the front for adjustment, if necessary.
- Avoid areas where the freezer would be exposed to direct sunlight, heat, extreme cold ambient temperatures or excessive moisture and high humidity. Installing it in the coolest area of the room will save energy consumption and running costs. Allow at least 20 cm clear space at the back and sides of the unit, and 70 cm above (Fig. 1), so air can circulate freely around the freezer.

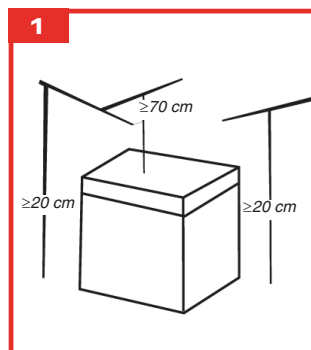

Connection

Settling

- Before plugging in your new freezer, let it stand upright for at least 4 hours to allow the refrigerant gases to settle into the compressor.

Connection

- Plug in the freezer and secure the power cord behind the unit, making sure the plug is accessible after installation.

First use

- The first time you turn the unit on, select the appropriate mode (see overleaf) and set the temperature control to the coldest temperature in the range. Then, after 4 hours, adjust the temperature to your needs.

Usage

- This appliance can be used as a chest freezer, or as a refrigerated storage cabinet for unfrozen food.
- For convenient access and organised storage, the cabinet is equipped with a wire basket.
- The thermostat is located at the front of the storage cabinet, in the bottom right-hand corner (Fig. 2). Use it to adjust the temperature in the cabinet.

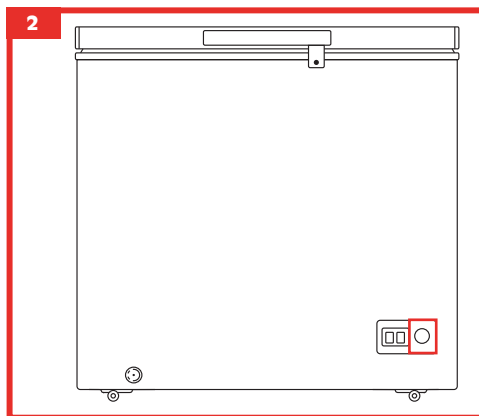

Controls

- The thermostat (Fig. 3) can be set to either "Fridge" or "Freezer" mode.
- When the thermostat is in the "Fridge" position, it means that the internal temperature is set to above 0°C. In "Fridge" mode, the appliance is suitable for short-term storage of fresh food. The temperature range in this mode is low enough to limit some bacterial growth, but it is not suitable for long-term storage of perishable foods.
- When the thermostat is in the "Freezer" position, it means that the internal temperature is set to below 0°C. In "Freezer" mode, the appliance is suitable for freezing fresh food and long-term storage (up to three months) of frozen food.

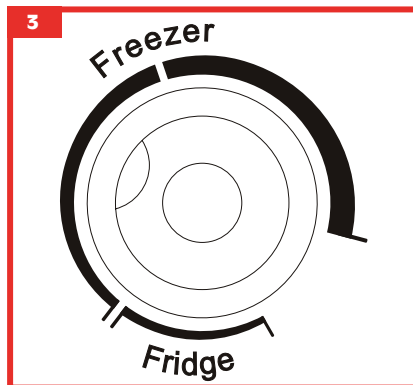

NOTE:

The power indicator light will illuminate when the appliance is turned on, and the running light will illuminate when the compressor is running.

Do NOT leave the unit operating with the thermostat operating in the coldest freezer position for an extended period of time, as this may damage the compressor and reduce the lifespan of this appliance.